

竞赛日程表

日期	时间	轮次	B	C	D	E	F
8.1	15: 00	1	D1LB1	D1LB2	D1LB3	D1LB4	
	18: 00	2	D2LB1	D2LB2	D2LB3	D2LB4	
	21: 00	3	D3LB5	D3LB6	D3LB7	D3LB8	
8.2	13: 00	4	D4LB1	D4LB2	D4LB3	D4LB4	
	16: 00	5	D5LB11	D5LB9	D5LB12	D5LB10	
	18: 00	6	D6LB5	D6LB6	D6LB7		
	21: 00	7	D7LC2	D7LC4	D7LC1	D7LC3	
8.3	09: 00	8	D8LC2	D8LB6	D8LC1	D8LB5	
	12: 00	9	D9 (4)	D9 (3)	D9 (2)	D9 (1)	
	15: 00	10	D10LB7	D10 (2)	D10LB8	D10 (1)	
	18: 00	11	D11LB9		D11LB11	D11LB10	
	21: 00	12	D12LC2	D12LC3	D12LC1	D12LC4	
8.4	10: 00	13	D13 (1)	D13LB13	D13LB14	D13 (2)	
	13: 00	14	D14 (1)	D14 (1)	D14 (3)	D14 (2)	D14 (2)
	16: 00	15	D15LB13	D15 (1)	D15 (2)	D15LB12	D15
	19: 00	16	D16 (2)	D16 (1)	D16 (1)	D16 (2)	D16 (3)
8.5	09: 00	17		D17LB14	D17 (2)	D17 (1)	
	13: 00	18	D18	D18	D18	D18LB15	
	16: 00	19		D19	D19		

注： 1、比赛采用 8 局制和自由防守区 5 球制

2、 代表混双场次， 代表男子场次， 代表女子场次

3、赛道内为比赛代码，各队根据比赛结果到相应赛道比赛



混双组竞赛轮次对阵

A





B

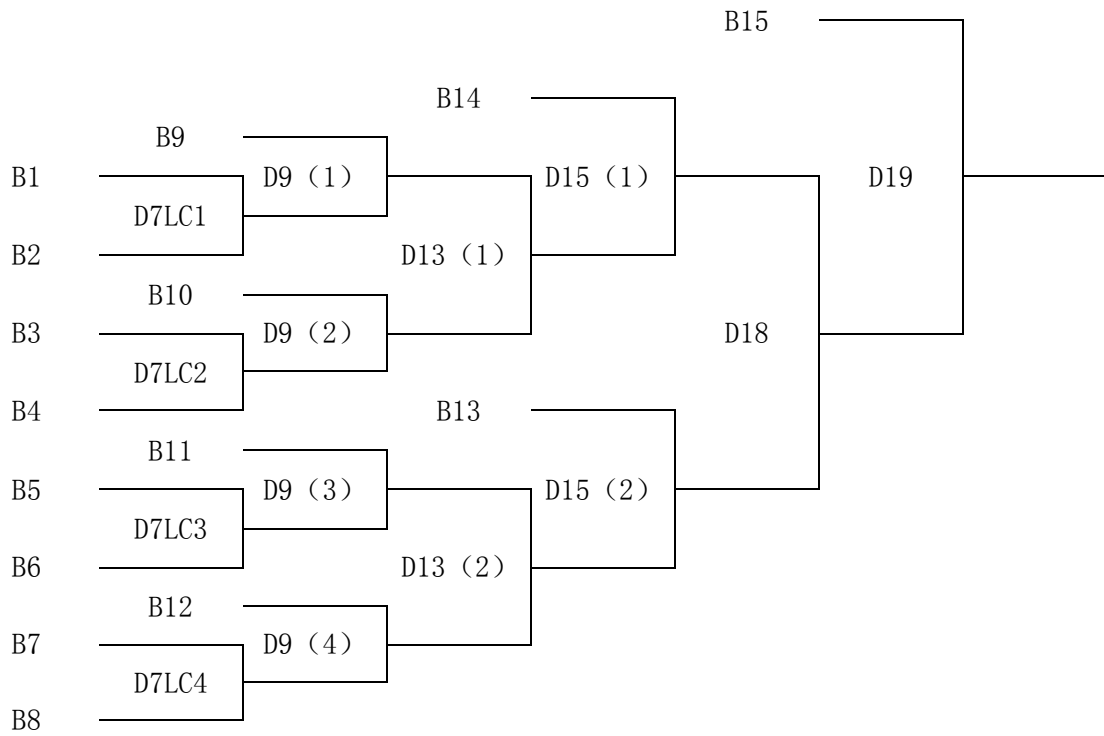

C

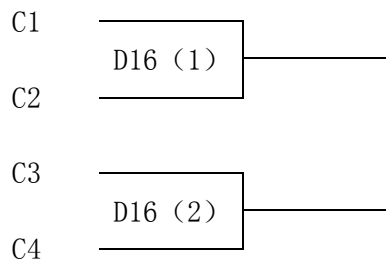



男子组竞赛轮次对阵

A

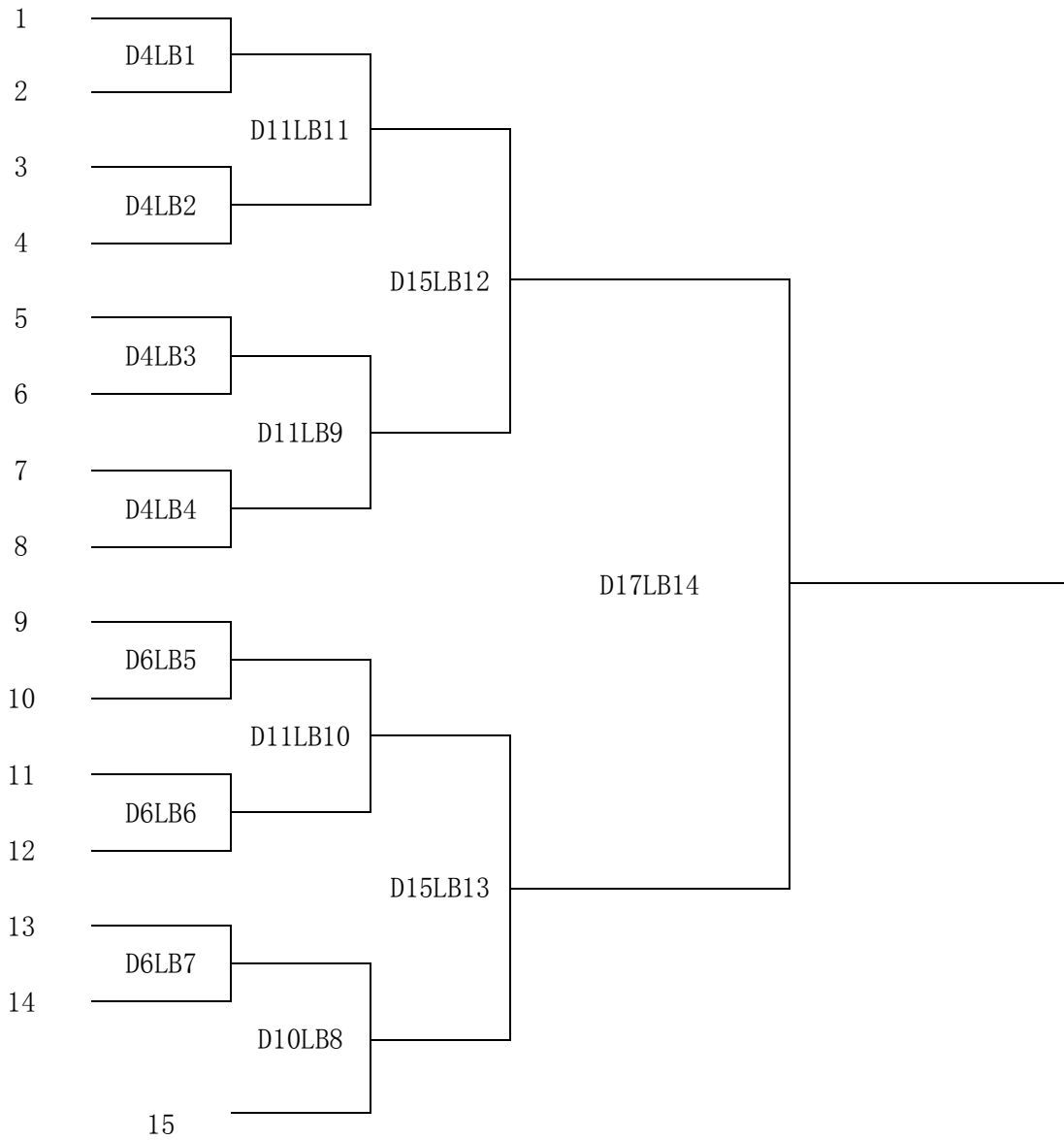

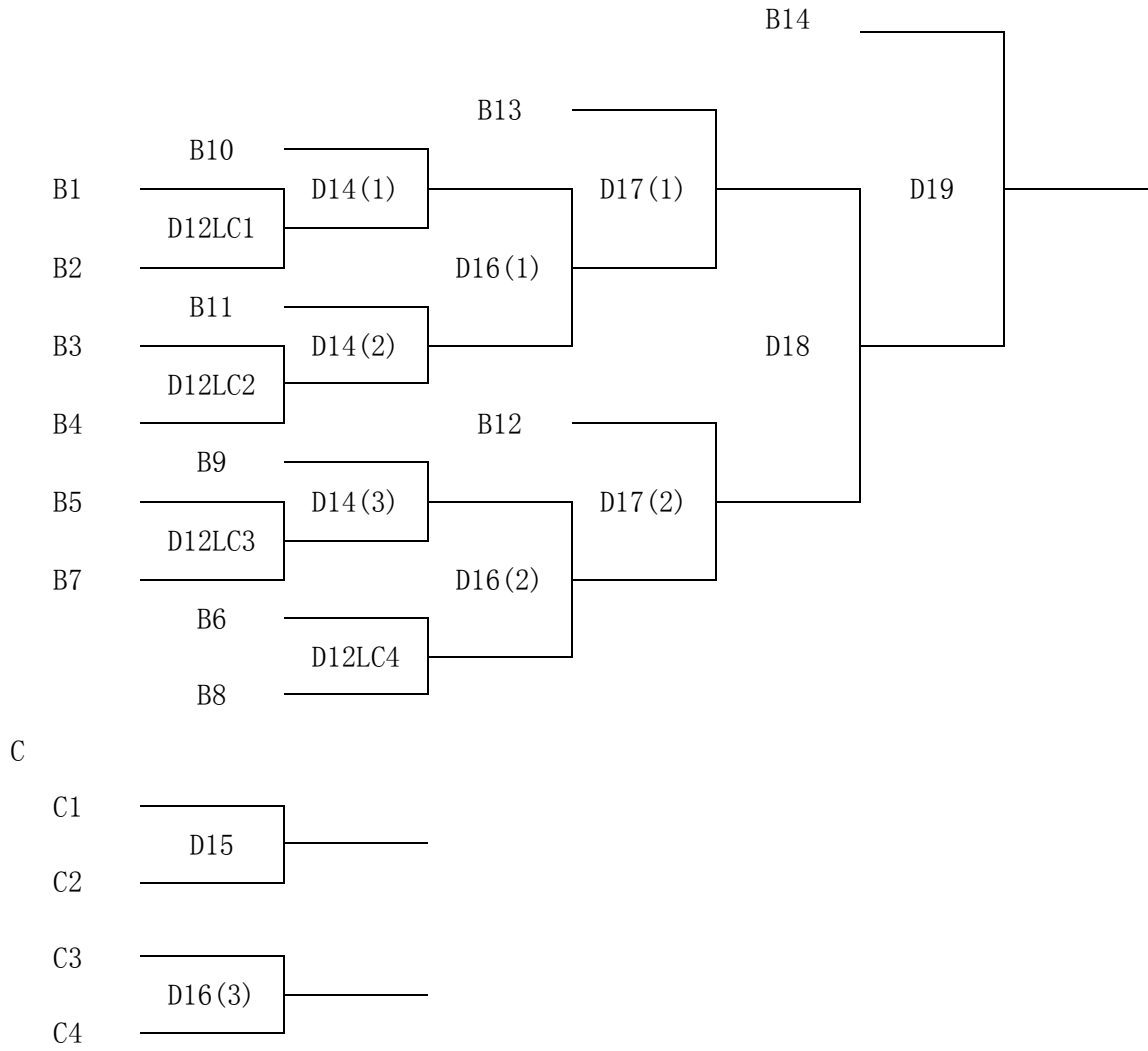



女子组竞赛轮次对阵

A

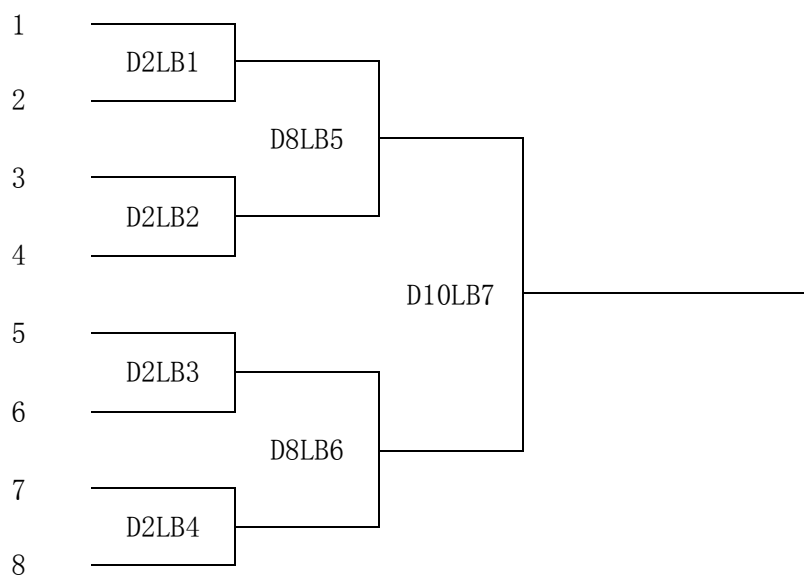

B

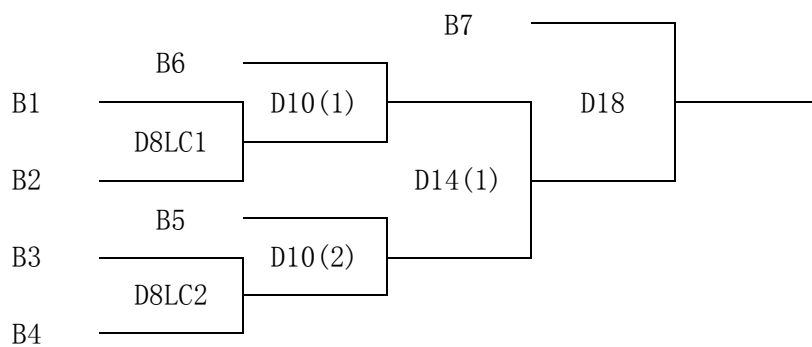

C

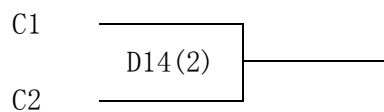

注： 1、各队序号（混双、女子1-15，男子1-8）由抽签决定，按序落位
2、每组的A段和B段冠军为最终选拔出的队伍